

NFPA No.

24

S700385

OUTSIDE PROTECTION 1970

CHARLES S. MORGAN LIBRARY
NATIONAL FIRE PROTECTION ASSOCIATION
1 BATTERYMARCH PARK
QUINCY, MA 02269-9101



\$1.25

Copyright © 1970

NATIONAL FIRE PROTECTION ASSOCIATION
International

60 Battery March Street, Boston, Mass. 02110

6M-6-70-WP-SC

Printed in U.S.A.

Official NFPA Definitions

Adopted Jan. 23, 1964; Revised Dec. 9, 1969. Where variances to these definitions are found, efforts to eliminate such conflicts are in process.

SHALL is intended to indicate requirements.

SHOULD is intended to indicate recommendations or that which is advised but not required.

APPROVED means acceptable to the authority having jurisdiction. The National Fire Protection Association does not approve, inspect or certify any installations, procedures, equipment or materials nor does it approve or evaluate testing laboratories. In determining the acceptability of installations or procedures, equipment or materials, the authority having jurisdiction may base acceptance on compliance with NFPA or other appropriate standards. In the absence of such standards, said authority may require evidence of proper installation, procedure or use. The authority having jurisdiction may also refer to the listings or labeling practices of nationally recognized testing laboratories,* i.e., laboratories qualified and equipped to conduct the necessary tests, in a position to determine compliance with appropriate standards for the current production of listed items, and the satisfactory performance of such equipment or materials in actual usage.

*Among the laboratories nationally recognized by the authorities having jurisdiction in the United States and Canada are the Underwriters' Laboratories, Inc., the Factory Mutual Research Corp., the American Gas Association Laboratories, the Underwriters' Laboratories of Canada, the Canadian Standards Association Testing Laboratories, and the Canadian Gas Association Approvals Division.

LISTED: Equipment or materials included in a list published by a nationally recognized testing laboratory that maintains periodic inspection of production of listed equipment or materials, and whose listing states either that the equipment or material meets nationally recognized standards or has been tested and found suitable for use in a specified manner.

LABELED: Equipment or materials to which has been attached a label, symbol or other identifying mark of a nationally recognized testing laboratory that maintains periodic inspection of production of labeled equipment or materials, and by whose labeling is indicated compliance with nationally recognized standards or tests to determine suitable usage in a specified manner.

AUTHORITY HAVING JURISDICTION: The organization, office or individual responsible for "approving" equipment, an installation, or a procedure.

Statement on NFPA Procedures

This material has been developed in the interest of safety to life and property under the published procedures of the National Fire Protection Association. These procedures are designed to assure the appointment of technically competent Committees having balanced representation from those vitally interested and active in the areas with which the Committees are concerned. These procedures provide that all Committee recommendations shall be published prior to action on them by the Association itself and that following this publication these recommendations shall be presented for adoption to the Annual Meeting of the Association where anyone in attendance, member or not, may present his views. While these procedures assure the highest degree of care, neither the National Fire Protection Association, its members, nor those participating in its activities accepts any liability resulting from compliance or non-compliance with the provisions given herein, for any restrictions imposed on materials or processes, or for the completeness of the text.

Copyright and Republishing Rights

This publication is copyrighted © by the National Fire Protection Association. Permission is granted to republish in full the material herein in laws, ordinances, regulations, administrative orders or similar documents issued by public authorities. All others desiring permission to reproduce this material in whole or in part shall consult the National Fire Protection Association.

S700385

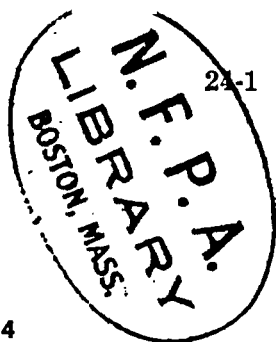

Standard for
Outside Protection

NFPA No. 24 — 1970

1970 Edition of No. 24

This edition of the Standard for Outside Protection incorporates revisions adopted by the National Fire Protection Association at its 1970 Annual Meeting, on recommendation of the Committee on Standpipes and Outside Protection. It supersedes the edition of 1969 and all prior editions. Changes from the 1969 edition include: revisions to Figure 26-1 (old 26), 3402, 9502 and Figure 96-39. Figures 26-2 and 26-3 are new.

Origin and Development of No. 24

In 1903 the NFPA Committee on Hose and Hydrants first presented Specifications for Mill Yard Hose Houses taken substantially from a standard published by the Eastern Factory Insurance Association. This text was revised and adopted in 1904. The NFPA Committee on Field Practice amended the Specifications in 1926, published as NFPA No. 25.

In 1925 the Committee on Field Practice prepared a Standard on Outside Protection, Private Underground Piping Systems Supplying Water for Fire Extinguishment, which was adopted by NFPA. It was largely taken from the 1920 edition of the NFPA Automatic Sprinkler Standard, Section M on Underground Pipes and Fittings. In September 1931, a revision was made with the resulting Standard designated as NFPA No. 24.

In 1953, on recommendation of the Committee on Standpipes and Outside Protection, the two standards (No. 24 and No. 25) were completely revised and adopted as NFPA No. 24. Amendments were made leading to separate editions in 1955, 1959, 1962, 1963, 1965, 1966, 1968, and 1969. This 1970 edition contains the latest recommendations of the Association.

Committee on Standpipes and Outside Protection

Kenneth J. Carl, Chairman,

American Insurance Assn., 85 John St., New York, N. Y. 10038

- | | |
|-----------------------------------------------------------------------------------------------|------------------------------------------------------------------------------|
| S. E. Auck , Underwriters' Laboratories, Inc. | Richard Martineau , National Automatic Sprinkler & Fire Control Assn. |
| William H. Avery , Assn. of Mill & Elevator Mutual Insurance Cos. | Edward P. McAniff , Bayside, Queens, N. Y. |
| Allen S. Dimoff , Fire Insurance Rating Bureau. | A. J. Mercurio , Factory Insurance Assn. |
| Douglas C. Doody , American Mutual Insurance Alliance. | Richard T. Montgomery , National Park Service. |
| Chief Robert Ely , California Fire Chiefs Assn. | James W. Nolan , James W. Nolan Co. |
| E. E. Hinderer , Caterpillar Tractor Co. | Ray Simpson , International Assn. of Fire Chiefs. |
| R. H. Jensen , Illinois Institute of Technology. | J. S. Slicer , Factory Mutual Research Corp. |
| T. C. Jester , Manufacturers Standardization Society of the Valve & Fittings Industry. | Edward B. Smith , Fire Marshals Assn. of North America. |
| I. L. Lamar , South-Eastern Underwriters Assn. | W. Harry Smith , Cast Iron Pipe Research Assn. |
| C. T. Mallory , National Automatic Sprinkler & Fire Control Assn. | J. Milton Wright , Garden City, N. Y. |
| Alan R. Marshall , Powhatan Brass & Iron Works. | R. J. Wright , Underwriters' Laboratories of Canada. |

Alternates.

- | | |
|----------------------------------------------------------------------------------------|-----------------------------------------------------------------------------------|
| Richard H. Erbe , Fire Insurance Rating Bureau. (Alternate to Allen S. Dimoff.) | James G. O'Hanlon , Staten Island, N. Y. (Alternate to Edward P. McAniff.) |
| Joel B. Husted , American Insurance Assn. (Alternate to Kenneth J. Carl.) | W. J. Swingler , Factory Insurance Assn. (Alternate to A. J. Mercurio.) |

Scope: Standpipe and hose systems; private underground piping systems supplying water for fire extinguishment; hydrants; hose houses; valves; indicator posts; supervision and care of valves controlling water supplies for fire protection; use of sprinkler systems and standpipe systems by fire departments.

Contents

Chapter	Page
1 General Information	24-4
2 Water Supplies	24-5
3 Valves	24-11
4 Hydrants	24-14
5 Hose Houses and Equipment	24-16
6 Fire Hose Care and Maintenance	24-21
7 Heavy Caliber Hose Streams	24-23
8 Underground Pipe and Fittings	24-25
9 Rules for Laying Pipe	24-29

Standard for Outside Protection

NFPA No. 24 — 1970

Foreword.

This Standard covers only the general details of yard piping supplying automatic sprinklers, open sprinklers, water spray systems, foam systems, yard hydrants, monitor nozzles, roof hydrants, or standpipes, with references also to houses and care and maintenance of fire hose.

The following NFPA standards should be consulted for specific information. These are published by the National Fire Protection Association in pamphlet form and also in the National Fire Codes and are available from the NFPA Office, 60 Batterymarch Street, Boston, Massachusetts 02110.

- Care of Fire Hose, NFPA No. 198-1969.
- Centrifugal Fire Pumps, NFPA No. 20-1970
- Fire Department Operations in Properties Protected by Sprinkler and Standpipe Systems, NFPA No. 13E-1966.
- Fire Hose, NFPA No. 196-1969.
- Foam Extinguishing Systems, NFPA No. 11-1970.
- Foam-Water Sprinkler and Foam-Water Spray Systems, NFPA No. 16-1968.
- Screw Threads and Gaskets for Fire Hose Couplings, NFPA No. 194-1968.
- Sprinkler Systems, NFPA No. 13-1969.
- Standpipe and Hose Systems, NFPA No. 14-1970.
- Supervision of Valves Controlling Water Supplies for Fire Protection, NFPA No. 26-1958.
- Water Spray Fixed Systems for Fire Protection, NFPA No. 15-1969.
- Water Tanks for Private Fire Protection, NFPA No. 22-1970.

The authority having jurisdiction should always be consulted before the installation of, or remodeling of, yard piping.

CHAPTER 1. GENERAL INFORMATION.

11. A layout plan shall be secured from or approved by the authority having jurisdiction in every case where new yard piping is contemplated.

12. The plan shall be drawn to scale and shall include all essential details such as:

(a) Size and location of all water supplies.

(b) Size and location of all piping, indicating where possible the class and type and depth of existing pipe, the class and type of new pipe to be installed and the depth to which it is to be buried.

(c) Size, type and location of valves. Indicate if located in pit or if operation is by post indicator or key wrench through a curb box. Indicate the size, type and location of meters, regulators and check valves.

(d) Size and location of hydrants, showing size and number of outlets and if outlets are to be equipped with independent gate valves. Indicate if hydrant house and equipment is to be provided and by whom.

(e) Sprinkler and standpipe risers and monitor nozzles to be supplied by the system.

(f) Location of fire department connection, if part of yard system, including detail of connection.

13. Piping should be laid so that the system can be extended with a minimum of expense. Possible future plant expansion should also be considered and the piping laid so that it will not be covered by buildings.

14. Installation work shall be done by fully experienced and responsible persons.

15. One or more framed plans of the complete system (kept corrected up to date) should be conspicuously posted for ready reference.

CHAPTER 2. WATER SUPPLIES.

21. Nature of Supply. The choice of water supplies shall be made in cooperation with the authority having jurisdiction.

22. Public Water System. (Applicable also to private reservoir and standpipe systems.)

2200. One or more connections from a reliable public water system of good pressure and adequate capacity furnishes an ideal primary supply. A high static water pressure shall not, however, be the criterion by which the efficiency of the supply is determined.

2201. Adequacy of water supply shall be determined by flow tests or other reliable means. Where flow tests are made the flow in gallons per minute together with the static and residual pressures should be indicated on the plan.

2202. Street mains should be of ample size, in no case smaller than 6 inches. Dead-end mains should be avoided if possible by arranging for mains supplied from both directions.

2203. No pressure regulating valve shall be used in water supply except by special permission of the authority having jurisdiction. Where meters are used they shall be of an approved type.

2204. Where connections are made from public waterworks systems it may be necessary to guard against possible contamination of the public supply. The requirements of the public health authority should be determined and followed.

2205. Connections to public waterworks systems should be controlled, where feasible, by indicator post valves of a standard type and located not less than 40 feet from the buildings protected. If this cannot be done, the indicator post valves shall be placed where they will be readily accessible in case of fire and not liable to injury. (See Section 33 for details.) Where indicator post valves cannot readily be used, as in a city block, underground gate valves should conform to these provisions and their locations and direction of turning to open should be plainly marked on the buildings.

2206. Connections for domestic or standpipe use over 2 inches in size shall conform to paragraph 2205.

23. Pumps.

2300. A fire pump installation consisting of pump, driver and suction supply, when of adequate capacity and reliability, and properly located, makes a good secondary supply. An automatically controlled fire pump taking water from a water main of adequate volume, or taking draft under a head from a reliable storage of adequate capacity, may under certain conditions be accepted by the authority having jurisdiction as a single supply.

2301. Where a centrifugal pump is the only means of supplying water, the pump should be provided with supervisory service from an approved central station system or from an approved proprietary system or their substantial equivalent, which shall provide means for positive indication at the central office that the pump has operated normally. This arrangement is to be in addition to the supervision of power supply and other features that may be required by the authority having jurisdiction. These pumps should be operated at least monthly by the supervisory service representative, and at more frequent intervals where the authority having jurisdiction so requires.

NOTE: See sections dealing with sprinkler equipment supervisory and water flow alarm services in Standard for the Installation, Maintenance and Use of Central Station Protective Signaling Systems for Guard, Fire Alarm and Supervisory Service, NFPA No. 71-1970, Standard for the Installation, Maintenance and Use of Local Protective Signaling Systems for Watchman, Fire Alarm and Supervisory Service, NFPA No. 72A-1967, Standard for the Installation, Maintenance and Use of Auxiliary Protective Signaling Systems for Fire Alarm Service, NFPA No. 72B-1967, Standard for the Installation, Maintenance and Use of Remote Station Protective Signaling Systems for Fire Alarm and Supervisory Service, NFPA No. 72C-1967, and Standard for Installation, Maintenance and Use of Proprietary Protective Signaling Systems for Watchman, Fire Alarm and Supervisory Service, NFPA No. 72D-1967. See separately published Standard for the Installation of Centrifugal Fire Pumps, NFPA No. 20-1970 and Standard for the Installation of Sprinkler Systems, NFPA No. 13-1969.

24. Tanks.

2401. Gravity Tanks. The capacity and elevation shall be determined by the authority having jurisdiction.

NOTE: See Standard for Water Tanks for Private Fire Protection, NFPA No. 22-1970.

2402. Pressure Tanks. When pressure tanks are to be used the authority having jurisdiction should be consulted.

NOTE: See Standard for Water Tanks for Private Fire Protection, NFPA No. 22-1970.

25. Penstocks or Flumes, Rivers or Lakes.

2501. Water supply connections from penstocks, flumes, rivers, lakes, or reservoirs shall be arranged to avoid mud and sediment, and should be provided with approved double removable screens or approved strainers installed in an approved manner.

26. Fire Department Connections.*

2600. A connection through which the public fire department can pump water into the sprinkler, standpipe or other system furnishing water for fire extinguishment makes a desirable auxiliary supply. For this purpose one or more fire department connections shall be provided in all cases except when permission of the authority having jurisdiction is obtained for their omission.

2601. Fire department connections shall be properly supported.

2602. There shall be no shut-off valve in the fire department connection.

2603. An approved straightway check valve shall be installed in each fire department connection, located as near as practicable to the point where it joins the system.

2604. The pipe between the check valve and the outside hose coupling shall be equipped with an approved automatic drip, arranged to discharge to a proper place.

2605. Hose connections shall be approved type.

2606. Hose coupling threads shall conform to those used by the local fire department. (American) National Stan-

*See Recommendations for Fire Department Operations in Properties Protected by Sprinkler and Standpipe Systems (NFPA No. 13E-1966).

standard Fire-Hose Coupling Screw Threads shall be used whenever they will fit the local fire department hose threads.

NOTE: See Standard for Screw Threads and Gaskets for Fire Hose Couplings, NFPA No. 194-1968.

2607. Hose connections shall be equipped with standard caps, properly secured and arranged for easy removal by fire departments.

2608. Hose connections should be on the street side of buildings and shall be located and arranged so that hose lines can be readily and conveniently attached to the inlets without interference from any nearby objects including buildings, fences, posts, or other fire department connections.

2609. (a) Hose connections shall be designated by a sign having raised letters at least one inch in size cast on a plate or fitting, reading for service designated: e.g. — "AUTO-SPKR." or "OPEN SPKR." or "STANDPIPE", etc.

b. If hose connection does not serve all of the building an appropriate and durable sign shall be attached.

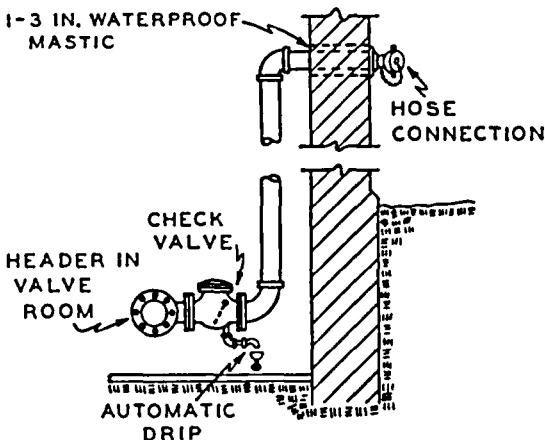
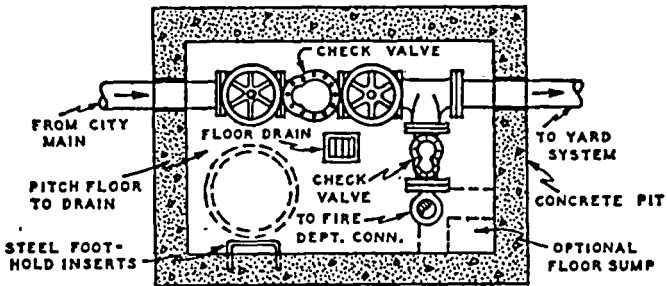
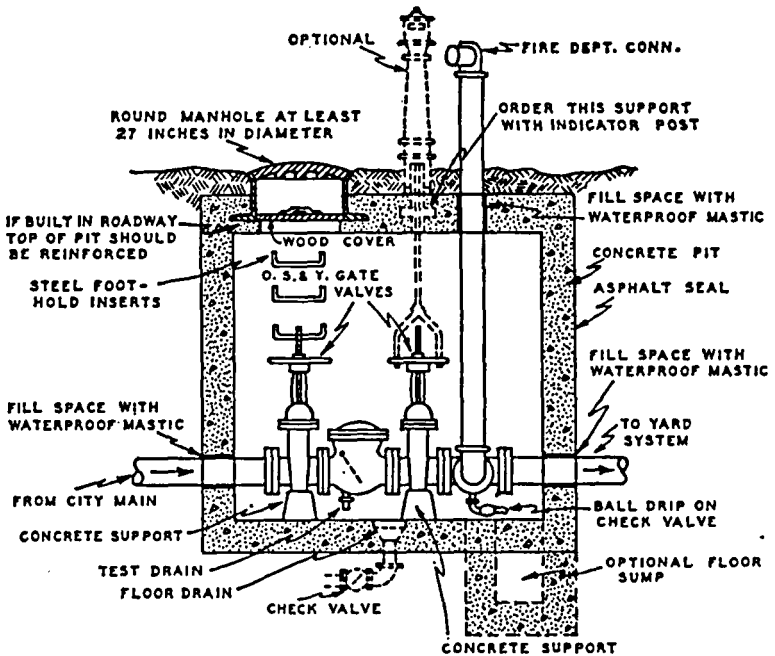

FIG. 26-1. FIRE DEPARTMENT CONNECTION



PLAN
NO SCALE



SECTION
NO SCALE

Figure 26-2. Typical city water pit — single check valve arrangement.

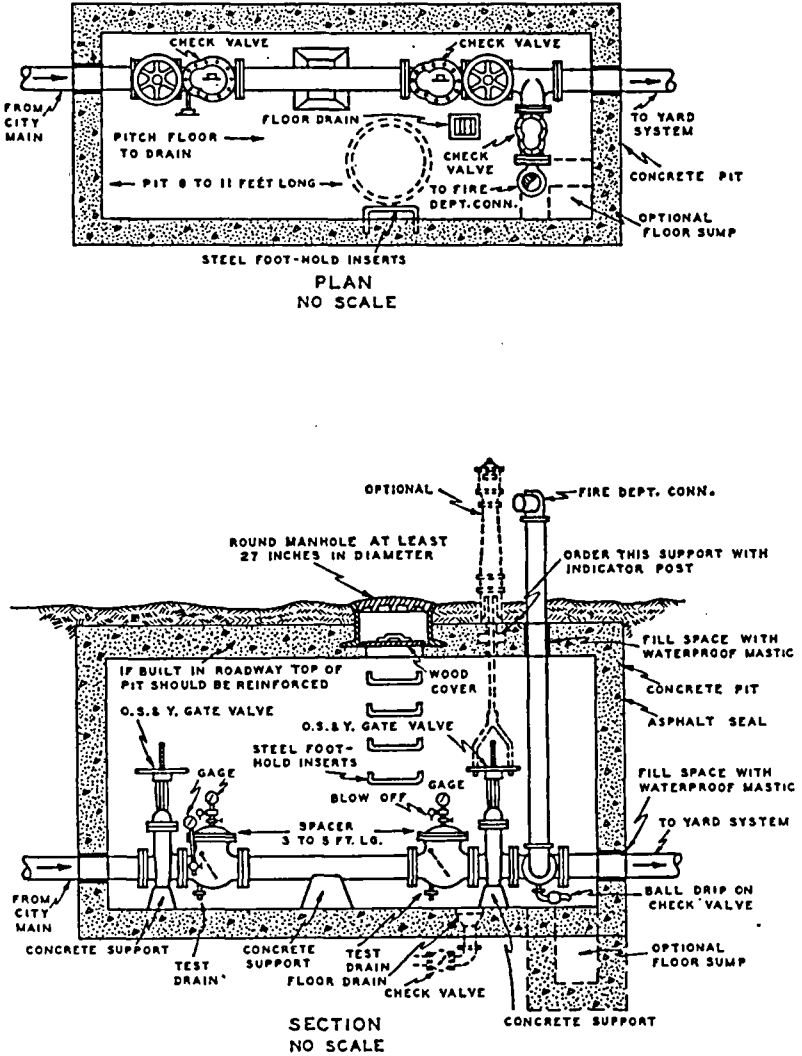

Figure 26-3. Typical city water pit — double check valve arrangement.

CHAPTER 3. VALVES.

31. Types of Valves.

3101. All control valves shall be approved outside screw and yoke or other approved indicating type. Approved quarter-turn valves equipped with approved indicator operators and approved inside screw gate valves equipped with approved post indicators meet this recommendation.

3102. Check valves shall be of an approved type.

32. Valves Controlling Water Supplies.

3201. At least one control valve shall be installed in each source of water supply except fire department connections.

3202. Where there is more than one source of water supply, a check valve shall be installed in each connection, except that, where cushion tanks are used with automatic fire pumps, no check valve is required in the cushion tank connection.

3203. A control valve should be installed on each side of each check valve, except that, in the discharge pipe from a pressure tank or a gravity tank of less than 15,000 gallons capacity, no control valve need be installed on the tank side of the check valve.

3204. Where a gravity tank is located on a tower in the yard, the control valve on the tank side of the check valve should be an outside screw and yoke or approved indicating valve; the other should be either an outside screw and yoke, approved indicating or an approved valve having a post type indicator. Where a gravity tank is located on a building both control valves should be outside screw and yoke or approved indicating valve; and all fittings inside the building, except the drain tee and heater connections, shall be under the control of an approved valve.

3205. When a pump, located in a combustible pump house or exposed to danger from fire or falling walls, or a tank, discharges into a yard main fed by another supply, either the check valve in the connection should be located in a pit or the control valve should be of the post indicator type located a safe distance outside buildings.

3206. Check valves on tank or pump connections when located underground may be placed inside of buildings and

at a safe distance from the tank riser or pump, except in cases where the building is entirely of one fire area, when it is ordinarily considered satisfactory to locate the check valve overhead in the lowest level.

3207. All control valves controlling water supplies for sprinklers should be located where readily accessible.

33. Post Indicator Valves.

3301. Every connection from the yard main to a building shall be provided with a post indicator valve, except where other arrangements are acceptable to the authority having jurisdiction.

3302. Post indicator valves should be located not less than 40 feet from buildings; but where necessary to place a valve close to a building, it should be located at a blank part of the wall.

3303. Post indicator valves shall be set with regard to the final grade line so that the top of the post will be about 36 inches above the ground.

3304. Post indicator valves may require protection against mechanical damage. This work should be promptly attended to if not included in the contract.

34. Valves in Pits.

3401. Where it is impracticable to provide a post indicator valve, valves may be placed in pits through permission of the authority having jurisdiction. Valve pits, except those located at or near the base of the riser of an elevated tank, should, insofar as practicable, satisfy the objectives of Paragraph 3402.

NOTE: For valve pits located at or near the base of a tank riser, refer to Standard for Water Tanks for Private Fire Protection, NFPA No. 22-1970.

3402. When used, valve pits should be of adequate size and readily accessible for inspection, operation, testing, maintenance, and removal of equipment contained therein. They should be constructed and arranged to properly protect the installed equipment from movement of earth, freezing, and accumulation of water. Poured-in-place or precast concrete, with or without reinforcement, or brick (all depending upon soil conditions and size of pit) are appro-

appropriate materials for construction of valve pits. Other approved materials may be used. Where the water table is low and the soil is porous, crushed stone or gravel may be used for the floor of the pit. See Figures 26-2 and 26-3 for suggested arrangements.

3403. A wrench or crow-foot with a long handle should be provided for each valve, and kept in the pit where it can be reached from the yard level. The location of the valve should be clearly marked on neighboring buildings, and the cover of the pit should be kept free from dirt and snow at all times.

35. Sectional Valves.

3501. Large yard systems shall have sectional controlling valves at appropriate points, in order to permit sectionalizing the system in the event of a break, or for the making of repairs or extensions.

3502. A valve should be provided on each bank where a main crosses water; it is also recommended that valves be installed to shut off sections of pipe under buildings. (See Paragraph 9301.)

36. Identifying and Securing.

3601. All control valves shall be plainly marked indicating the section or portion controlled. To assure that valves are kept open, it is essential to provide central station proprietary valve supervisory service and/or to secure the valves in the open position using an acceptable type of seal which must be destroyed before the valve can be closed. Weekly recorded inspections shall be made.

NOTE: See Standard for Supervision of Valves Controlling Water Supplies for Fire Protection, NFPA No. 26-1958.

CHAPTER 4. HYDRANTS.

41. Type of Hydrants.

4101. Hydrants shall be of approved type and have not less than a 6-inch connection with the mains. A valve should be installed in the hydrant connection. The number, size and arrangement of outlets, the size of main valve opening and the size of barrel shall be suitable for the protection to be provided and shall be approved by the authority having jurisdiction. Independent gate valves on 2½-inch outlets may be used. (See Chapter 5.)

4102. Hydrants should be tested periodically for proper functioning in accordance with the requirements of the authority having jurisdiction but at least semi-annually.

42. Number and Location.

4201. A sufficient number of hydrants shall be installed to provide two streams for every part of the interior of each building not covered by standpipe protection and to provide hose stream protection for every exterior part of each building by the use of the lengths of hose normally attached to the hydrants. There shall be sufficient hydrants to concentrate the required fire flow about any important building with no hose line exceeding 500 feet in length.

NOTE: Public hydrants when available on an acceptable public water system may be considered to comply with this requirement.

4202. For average conditions hydrants should be placed about fifty feet from the buildings protected. Where it is impossible to place them at this distance, they may be put nearer, provided they are set in locations where the chance of injury by falling walls is small, and from which men are not likely to be driven by smoke or heat. Usually in crowded mill yards they can be placed beside low buildings, near brick stair towers, or at angles formed by substantial brick walls which are not likely to fall.

43. Setting.

4301. Hydrants shall be set on flat stones or concrete slabs with about half a barrel of small stones (or equivalent) placed about the bottom to insure quick drainage from the drip. They shall not be placed near retaining walls where there is danger of frost through the wall.

4302. Where soil is of such a nature that the hydrants will not drain properly with the arrangement specified in Paragraph 4301, the hydrant drain shall be connected to a drain by not less than a 2-inch cast iron pipe; or some other means acceptable to the authority having jurisdiction shall be provided to keep the hydrant barrels clear of water.

4303. In setting hydrants due regard should be given to final grade line; centers of hose outlets should be about 18 inches above the floor of the hose house or 18 inches above ground.

4304. Hydrants shall be fastened to piping by standard clamps or be properly anchored. (See Fig. 96.)

4305. Hydrants may require protection against mechanical damage. This work shall be promptly attended to if not included in the sprinkler contract.

CHAPTER 5. HOSE HOUSES AND EQUIPMENT.

51. Hose.

5101. An adequate supply of hose and equipment shall be provided when hydrants are intended for use by plant personnel or a fire brigade. The quantity and type of hose and equipment will depend upon the number and location of hydrants relative to the protected property, the extent of the hazard, and the fire fighting capabilities of the potential users. The authority having jurisdiction should be consulted.

5102. Hose shall be stored so it is readily accessible and is protected from the weather. This may be done by the use of hose houses or hose reels.

52. Location.

5201. When hose houses are used, they should be located over the hydrant and arranged so that the hydrant will be as close to the front of the house as possible and still allow sufficient room back of the doors for the hose gates and the attached hose.

5202. When hose reels are used they shall be located so they may be brought quickly into use at a hydrant.

53. Construction.

5301. Hose houses shall be of substantial construction on adequate foundations. The construction shall be such as to protect the hose from weather and vermin and designed so that hose lines can be quickly brought into use. Clearance shall be provided for proper operation of the hydrant wrench. Proper ventilation shall be provided. The exterior shall be painted or otherwise suitably protected against deterioration.

54. Size and Arrangement.

5401. Hose houses shall be of a size and arrangement to provide shelves or racks for the hose and equipment. For typical hose houses see Figures 54-1 to 54-3 inclusive. For other types of hose houses or equivalent enclosures consult the authority having jurisdiction.

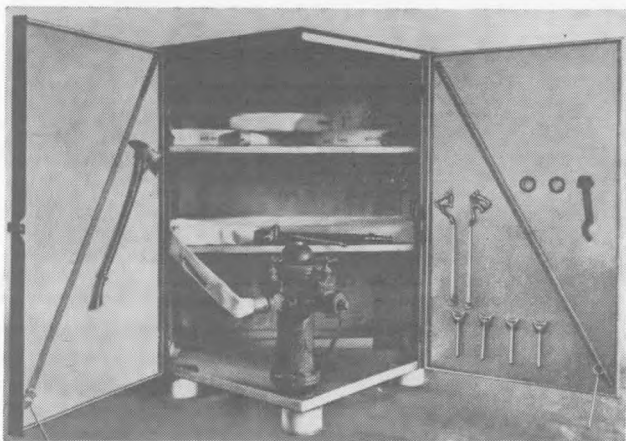

Fig. 54-1 House of five-sided design for installation over a yard hydrant. Such houses may be of wood or steel with a tight floor installed after erection.

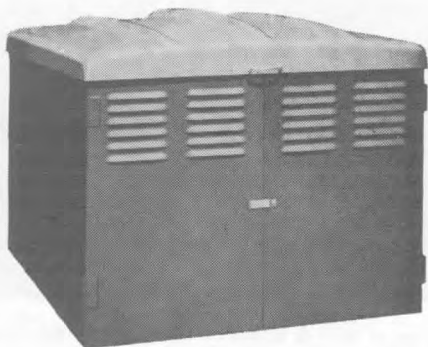

Fig. 54-2 Steel house of compact dimensions for installation over a yard hydrant. House is shown closed. Top lifts up and doors on front side open for complete accessibility.

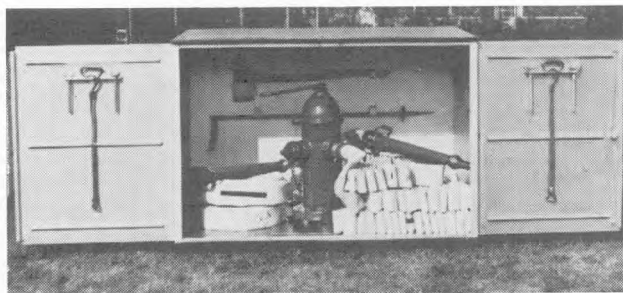

Fig. 54-3 Hose house of compact dimensions for installation over a yard hydrant. Construction may be steel or aluminum.

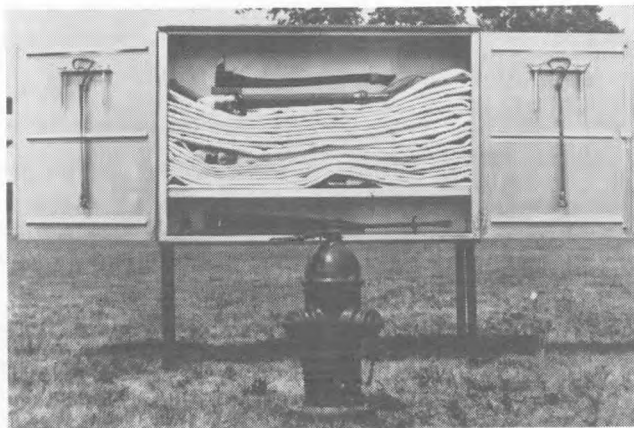

Fig. 54-4. Hose house of steel or aluminum construction. This type can be installed on legs as illustrated or installed on a wall near, but not directly over, a yard hydrant.

NOTE: Common materials used to construct hose houses are wood, steel and aluminum. Manufacturers have provided the photographs shown in this text, but they are not identified because nearly all major fire appliance distributors can furnish hose houses in designs similar in purpose to the designs shown. For equipment details of hose houses, see Section 56, 57 and 58.

55. Marking.

5501. Hose houses shall be plainly marked in large letters with the fire hydrant number or hose house number.

56. Equipment — General.

5601. Each hose house shall be equipped with —

2 — Underwriters' play pipes.	1 — extra hydrant wrench (in
1 — pair play pipe brackets.	addition to wrench on hy-
1 — fire axe.	drant).
1 — pair fire axe brackets.	4 — coupling spanners.
1 — crowbar.	2 — hose and ladder straps.
1 — pair crowbar brackets.	1 — Underwriters' play pipe
	holder.

2 — 2½-inch hose washers (spares).

The above may be modified by the authority having jurisdiction depending upon the local conditions.

57. Couplings.

5701. Couplings shall be of the same size and thread and directly interchangeable with those of the nearest fire department that would respond to an alarm, or where there is no fire department, couplings shall be interchangeable with those of the nearest plant that would be able to render practical assistance.

5702. Threads shall be in accordance with paragraph 2606. Where couplings are not interchangeable, proper adapters shall be provided in the hose houses.

5703. Where the fire department does not have double female couplings, it is an excellent practice to provide them with the hose equipment.

NOTE: These are for use during an emergency for connecting hose from hydrant to hydrant.

58. Nozzles.

5801. Nozzles shall be of approved type.

NOTE: Standard play pipes are smooth tapering tubes 30 inches long wound and painted, with a 1½-inch smooth bore nozzle. For use of other types of approved nozzles consult the authority having jurisdiction.

59. Domestic Service Use Prohibited.

5901. The use of hydrants and hose for purposes other than fire or fire drills shall be prohibited.

CHAPTER 6. FIRE HOSE CARE AND MAINTENANCE.

61. General.

NOTE: See Care of Fire Hose, NFPA No. 198-1969.

6100. Woven jacket rubber-lined fire hose should preferably be kept in a cool, dry location such as a small, well-ventilated hose house with slatted shelves for good air circulation. Mildew will attack hose fabric if the hose is stored in a damp location. Hose jackets can be treated to retard mildew growth. Corrosive chemicals will weaken the fabric and cause the hose to fail. Gasoline, oils, or organic solvent will deteriorate the rubber lining. Continued exposure to high temperatures will cause the rubber lining to harden and crack. The useful life of woven jacket rubber-lined hose at inside hose connections in dry, well-ventilated rooms with ordinary temperatures will be about the same as yard hose, having the same maintenance.

6101. When hose is kept in a hose house at a hydrant, it is good practice to have two or three lengths connected together and attached to the hydrant ready for instant use. Where hose is folded on the shelves for easy removal, the folds should be as long as possible. Hose that is not connected to the hydrant should be kept in rolls, as this eliminates the many sharp bends and kinks which tend to crack the rubber lining when hose is folded. In rolling the hose, place the male coupling on the inside of the coil, using care to prevent sharp bends near this coupling.

6102. Fire hose should be reserved for fighting fires; for other uses, a separate supply of proper hose should be provided.

6103. The hose shall not be stored inside a main building, where it might be inaccessible in case of fire.

6104. Where hose may be subjected to acids, acid fumes, or other corrosive materials, as in chemical plants, the purchase of approved rubber-covered rubber-lined hose is advised. For plant yards containing rough surfaces that will cause heavy wear or where working pressures are above 150 pounds per square inch, double jacketed hose should be provided.

62. Testing Hose.

6201. Hose should be tested once a year. The test pressure shall be at least equivalent to the maximum static yard pressure or the highest fire pump shutoff pressure, whichever is greater, but in no case less than 150 pounds per square inch. These tests relieve stresses which are set up in the jacket and in the rubber lining when it is held in one position for a long time. Pressure used at date of test should be recorded on a card tacked on the hose house door.

NOTE: See Standard for Fire Hose, NFPA No. 196-1969.

NOTE: The hydrostatic pressure test may be made as follows: A threaded cap with petcock or small valve for air outlet should be attached to one end of the hose line, with the other end connected to the fire or hydrostatic test pump if there is one available, or otherwise to the normal water supply. The hose shall be completely filled with water and the pressure applied gradually. Care should be taken to remove all the air from the hose before applying the test pressure, as a serious accident may result if the hose should burst or a coupling should disengage. The test pressure shall be maintained for at least one minute and then released. It is best to make these tests in warm weather to facilitate drying and prevent freezing the hose.

6202. All hose should not be removed from a hose house for testing at the same time because the time lost in returning it in case of fire might allow the blaze to spread beyond control.

6203. Faulty hose shall be discarded and replaced promptly with new hose that meets requirements of the Standard for Fire Hose, NFPA No. 196-1969. Faulty hose should not be stored in hose houses.

63. Cleaning Hose.

6301. After fire hose has been tested, or used for other purposes, it shall be cleaned and dried. When the fabric has been oil-soaked, the oil can be removed by warm water and a good grade of washing soap. This soap should be rinsed off before the hose is dried.

64. Drying Hose.

6401. Before returning the hose to service it should be carefully drained and dried. This can be done by hanging

the hose vertically or by laying it on a dry area with a slope of about 2 feet in 50. Sectional slatted racks about 52 feet long are used for such drying. When drying hose, be careful that the water will not drain from the hose and drop on the jacket of other hose underneath.

6402. When the hose is returned to the hose house, any folds that are made in the hose should be arranged to come at a different point each time the hose is replaced. Whenever possible, hose that has been stored in rolls should be used to replace that which has been stored folded since the last test or use.

CHAPTER 7. HEAVY CALIBER HOSE STREAMS.

71. Use and Location.

7100. Where large amounts of combustible materials are located in yards, such as log piles, lumber, railway car storage, etc., it is necessary to provide a ready means of delivering large quantities of water at effective pressures. This can best be accomplished by installing permanent monitor nozzles on the ground around the piles, and occasionally where necessary on special trestles or on roofs of buildings. (See Fig. 71.) Portable deluge sets for use with siamesed hose lines are also valuable in many cases.

7101. The location of this apparatus, the size of piping supplying it, the arrangement of control valves and the necessary water supplies, all demand special consideration in each individual case and the authority having jurisdiction should be consulted.

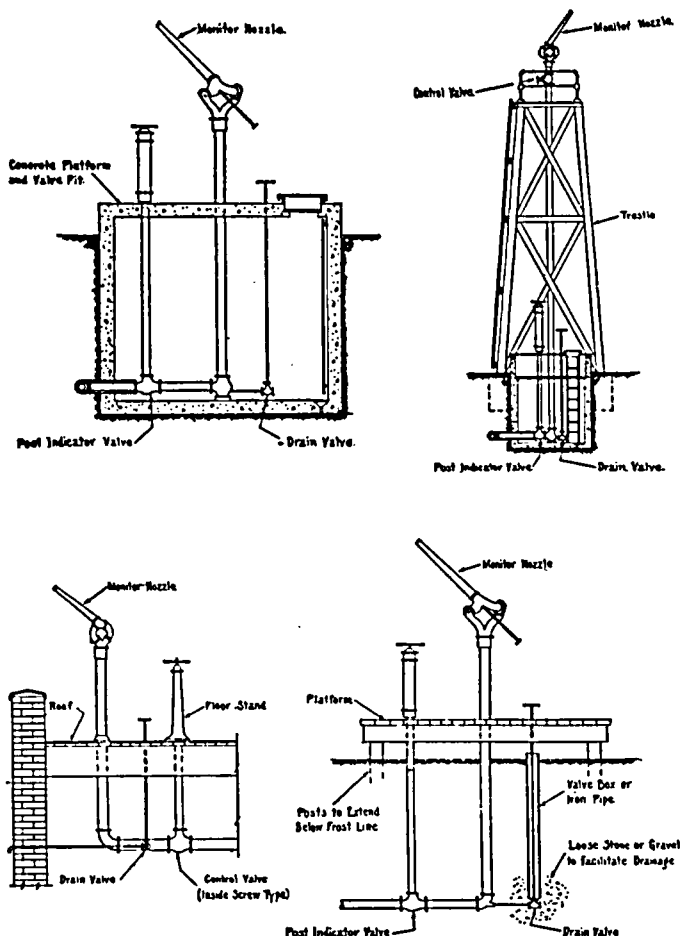

**FIG. 71. STANDARD MONITOR NOZZLES
GEAR CONTROL NOZZLES ARE ALSO SATISFACTORY**

CHAPTER 8. UNDERGROUND PIPE AND FITTINGS.

Publications designated AWWA are available from American Water Works Association, Inc., 2 Park Ave., N. Y. 10016. Publications designated ANSI are available from American National Standards Institute, 1430 Broadway, New York, N. Y. 10018. A number of the standards and specifications of AWWA have been adopted by and are available from Canadian Standards Association, 235 Montreal Road, Ottawa 7, Ont. Publications designated ASTM are available from the American Society for Testing and Materials, 1916 Race Street, Philadelphia, Pa. 19103. The address of the American Concrete Pipe Association is 228 North La Salle St., Chicago, Ill. 60601. In addition to the sources indicated below, specifications for cast iron pipe and fittings are available from Cast Iron Pipe Research Association, Suite 3440, Prudential Plaza, Chicago, Ill. 60601.

81. Selection of Pipe.

8101. Piping shall be approved asbestos cement, cast iron, ductile iron, reinforced concrete, steel or other approved pipe. Steel pipe shall have minimum thickness of 0.250 inch, and be coated and lined. See Paragraph 8301 for required coating and lining.

Underwriters' Laboratories, Inc., lists and labels cast iron and ductile iron pipe (cement-lined and unlined, coated and uncoated), asbestos-cement pipe and couplings and steel pipe. It lists under re-examination service reinforced concrete pipe (cylinder pipe, nonprestressed and prestressed).

Underwriters' Laboratories of Canada lists and labels or integrally marks cast iron and ductile iron pipe and asbestos-cement pipe and couplings.

8102. The type and class of pipe for a particular installation shall be determined through consideration of the maximum working pressure, the laying conditions under which the pipe is to be installed, soil conditions, corrosion, and susceptibility of pipe to other external loads including installation beneath buildings and traffic or vehicle loads.

Pipe Design Manuals. The following pipe design manuals may be used as a guide.

Standard Practice for the Selection of Asbestos-Cement Water Pipe, AWWA Handbook H2, 1964.

Manual for the Computation of Strength and Thickness of Cast Iron Pipe, ANSI A21.1-1967, AWWA H1-67, CSA B131.1-1958.

Concrete Pipe Handbook, American Concrete Pipe Association, 1965.

American Standard Practice Manual for the Thickness Design of Ductile Iron Pipe, ANSI A21.50-1965, AWWA H-3-65.

Steel Pipe Design and Installation, AWWA M11, Steel Pipe Manual, 1964.

Pipe Specifications. The various types of pipe are usually manufactured to one of the following specifications:

AWWA Tentative Standard for Asbestos-Cement Water Pipe, AWWA C400-65.

ASTM Specifications for Asbestos-Cement Pressure Pipe, ASTM 296-67.

American Standard for Cast-Iron Pipe Centrifugally Cast in Metal Molds, for Water or Other Liquids, ANSI A21.6-1962, AWWA C106-62, CSA A131.5-1963.

American Standard for Cast-Iron Pipe Centrifugally Cast in Sand-Lined Molds, for Water or Other Liquids, ANSI A21.8-1962, AWWA C108-62, CSA B131.7-1963.

American Standard for Ductile-Iron Pipe Centrifugally Cast in Metal Molds or Sand-Lined Molds, for Water or Other Liquids, ANSI A21.51-1965, AWWA C151-65.

AWWA Standard for Reinforced Concrete Water Pipe, Steel Cylinder Type, Not Prestressed, AWWA C300-64.

AWWA Standard for Reinforced Concrete Water Pipe, Steel Cylinder Type, Prestressed, AWWA C301-64.

AWWA Standard for Reinforced Concrete Water Pipe, Non-cylinder Type, Not Prestressed, AWWA C302-64.

AWWA Standard for Fabricated Electrically Welded Steel Water Pipe, AWWA C201-66.

AWWA Standard for Mill-Type Steel Water Pipe, AWWA C202-64.

82. Installation of Pipe and Fittings.

8201. Pipe and fittings shall be installed in accordance with manufacturers' instructions and in an approved manner.

Installation Standards. The following apply to the installation of pipe and fittings:

AWWA Tentative Standard for the Installation of Asbestos-Cement Water Pipe, AWWA C603-65.

AWWA Standard for the Installation of Cast-Iron Water Mains, AWWA C600-64.

Concrete Pipe Handbook, American Concrete Pipe Association, 1965.

Steel Pipe Design and Installation, AWWA M11, Steel Pipe Manual, 1964.

83. Coating and Lining.

8301. Where coating or lining or both are required for pipe or fittings, the coating or lining or both shall be approved.

Coating and Lining Standards. The following apply to the application of coating and linings:

American Standard for Cement Mortar Lining for Cast-Iron Pipe and Fittings for Water, ANSI A21.4-1964, AWWA C104-64.

AWWA Standard for Coal-Tar Enamel Protective Coatings for Steel Water Pipe, AWWA C203-66.

AWWA Standard for Cement-Mortar Protective Lining and Coating for Steel Water Pipe, AWWA C205-62.

AWWA Standard for Cement-Mortar Lining of Water Pipe Lines in Place, Sizes 16 inches and Over, AWWA C602-67.

84. Pipe and Fitting Joints.

8401. Pipe and fitting joints shall be approved type.

Pipe and Fitting Joint Standards. The following apply to joints used with the various types of pipe:

American Standard for Rubber Gasket Joints for Cast-Iron Pressure Pipe and Fittings, ANSI A21.11-1964, AWWA C111-64.

AWWA Standard for Field Welding of Steel Water Pipe Joints, AWWA C206-62.

AWWA Standard for Steel Pipe Flanges, AWWA C207-55.

American Standard for Cast-Iron Pipe Flanges and Flanged Fittings, Class 125, ANSI B16.1-1960, or Class 250, ANSI B16.2-1960.

85. Fittings.

8501. Fittings shall be approved type with joints and pressure class ratings compatible with the pipe used. Steel

pipe fittings shall be coated and lined. See paragraph 8301 for required coating and lining.

Fittings Standards. Fittings generally used are cast iron with joints to specifications of the manufacturer of the particular type of pipe. See Pipe and Fittings Joint Standards listed following paragraph 8401. Steel fittings also have some applications. There are the following standards on fittings:

American Standard for Cast Iron Fittings, 2-inch through 48-inch, for Water and Other Liquids, ANSI A21.10-1964, AWWA C110-64.

AWWA Standard for Dimensions for Steel Water Pipe Fittings, AWWA C208-59.

American Standard for Cast-Iron Pipe Flanges and Flanged Fittings, Class 125, ANSI B16.1-1960, or Class 250, ANSI B16.2-1960.

86. Sizes of Pipe.

8601. No pipe smaller than 6 inches in diameter shall be installed underground in yard systems for mains or hydrant branches.

8602. In moderately large plants a loop system is recommended because it provides water from several directions. In small plants a lesser amount of larger pipe may be installed which may be later extended to form a loop as the plant is enlarged.

8603. The size of the pipe supplying sprinkler systems and yard systems shall be approved by the authority having jurisdiction, due consideration being given to the construction and occupancy of the plant, to the volume and pressure of water required and to the adequacy of the supply.

8604. For purposes of computing friction loss in unlined cast iron pipe, use 100 as the coefficient C in Hazen and Williams formula; for cement-lined cast iron, lined steel, reinforced concrete, or asbestos cement pipe, use 120.

NOTE: The coefficients specified above are commonly used in water works practice which uses nominal pipe sizes and makes no special allowance for fittings. The authority having jurisdiction may accept a coefficient of 140 for cement-lined, reinforced concrete or asbestos-cement pipe, where the design is based on actual internal pipe sizes with proper allowance for added friction loss in all fittings and design calculations on this basis are submitted for approval.

CHAPTER 9. RULES FOR LAYING PIPE.

91. Depth of Cover.

9101. The depth of cover over water pipes should be determined by the maximum depth of frost penetration in the locality where the pipe is laid, and in those locations where frost is not a factor, the depth of cover shall be not less than $2\frac{1}{2}$ feet to prevent mechanical injury. Pipe under driveways shall be buried a minimum of 3 feet and under railroad tracks a minimum of 4 feet. Recommended depth of cover above the top of underground yard mains is indicated in Fig. 91.

9102. Depth of covering shall be measured from top of pipe to ground level and due consideration shall always be given to future or final grade and nature of soil.

NOTE: Greater depth is required in a loose gravelly soil (or in rock) than in compact, clayey soil. A safe rule to follow is to bury the top of pipe not less than one foot below the lowest frost line for the locality.

9103. As there is normally no circulation of water in private fire mains, they require greater depth of covering than do public mains.

92. Protection Against Freezing.

9201. Where it is impracticable to bury pipe it may be laid aboveground, provided the pipe is protected against freezing and mechanical injury, to the satisfaction of the authority having jurisdiction.

9202. Pipes should not be placed over raceways or near embankment walls, but if such an arrangement is unavoidable special attention shall be given to protection against frost.

9203. Where pipe is laid in raceways or shallow streams care shall be taken that there will be sufficient depth of running water between the pipe and the frost line during all seasons of frost; a safer method is to bury the pipe one foot or more under the bed of the waterway. Care shall also be taken to keep the pipe back from the banks a sufficient distance to avoid any danger of freezing through the side of the bank above the water line. Pipe shall be buried below frost line where entering the water.

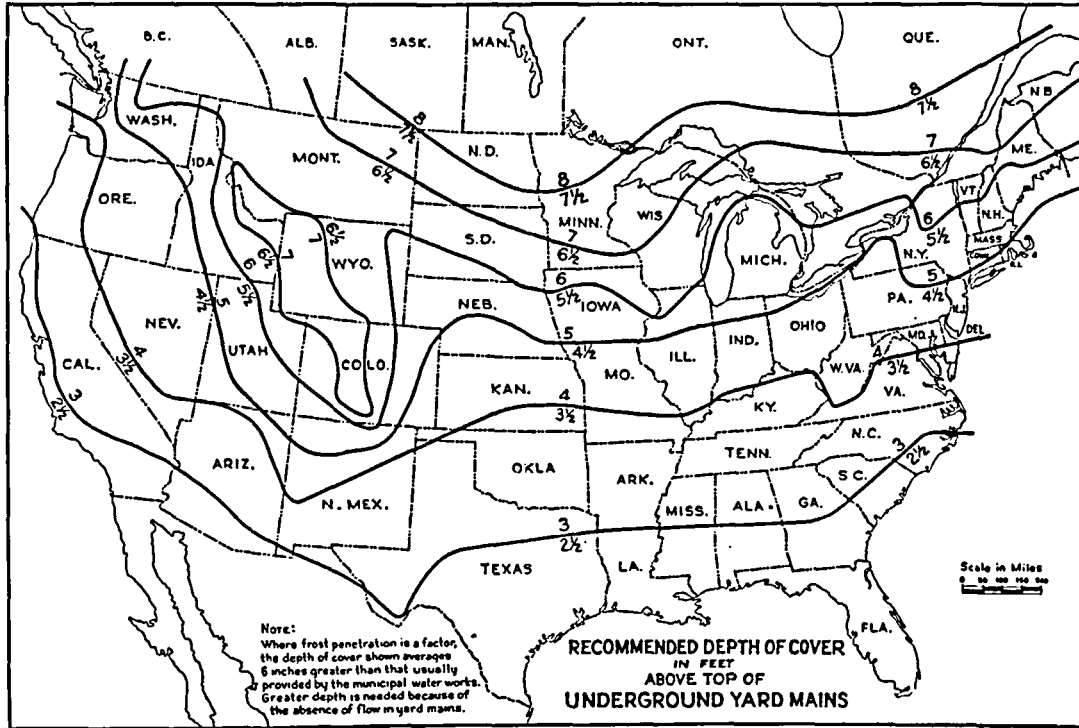

FIG. 91

93. Protection Against Damage.

9301. Pipe should not be run under buildings or under heavy piles of iron, coal, etc. Where piping necessarily passes under a building, the foundation walls shall be arched over the pipe. (See paragraph 3502.)

9302. Where riser is close to building foundations, underground fittings of proper design and type shall be used to avoid pipe joints being located in or under the foundations.

9303. Special care is necessary in running pipes under railroad tracks, under roads carrying heavy trucking, under large piles of iron, under buildings having heavy machinery liable to fall and under buildings containing hammers or other machinery or having heavy trucking which will subject the buried pipes to shock or vibration. Where subject to such breakage, pipes should be run in a covered pipe trench or be otherwise properly guarded. (See Section 81.)

94. Care in Laying.

9401. Pipes shall be clean inside when put in trenches and open ends shall be plugged when work is stopped, to prevent stones and foreign materials from entering such pipes.

9402. Pipes shall bear throughout their length and not be supported by the bell ends only.

9403. If ground is soft, or of a quicksand nature, special provision must be made for supporting pipe. For ordinary conditions of soft ground, longitudinal wooden stringers with cross ties will give good results. A reinforced concrete mat 3 inches or 4 inches thick in the bottom of the trench has also been used with excellent results. In extreme cases the stringers and cross ties or concrete mat may have to be supported on piles.

95. Pipe Joints.

9501. Joints shall be made tight. Poured lead joints, properly caulked, have proved satisfactory. Special joint compounds may be used when approved by the authority having jurisdiction; such joints if employed shall be made by persons familiar with the particular material used.

9502. When using bell and spigot pipe or fittings changes in grade or direction should never be made by shifting the pipe in the joints, as uneven lead joints result and these are likely to leak. When using mechanical joint pipe or fittings, or proprietary joints, or unleaded bell and spigot pipe or fittings, deflection shall not exceed that recommended by the manufacturer.

9503. Joints other than the bell and spigot type should be used only when approved.

96. Anchoring Fire Mains.

9601. All tees, plugs, caps, bends and hydrants on pipe installed underground shall be anchored. Pipe clamps and tie-rods, thrust blocks or other approved methods or devices may be used. The type of pipe and soil conditions determine the method.

9602. Details of acceptable pipe clamps and tie-rods are shown in Figs. 96-1 to 96-37.

9603. Fittings shall be provided with lugs when clamps and rods are to be used.

9604. After installation, rods and clamps should be thoroughly covered with asphalt or other acceptable corrosion-retarding material.

TABLE 9605

AREA OF BEARING FACE OF CONCRETE THRUST BLOCKS

Pipe Size	¼ Bend	½ Bend	Tees, Plugs, Caps and Hydrants
Inches	Square Feet	Square Feet	Square Feet
4	2	2	2
6	5	3	4
8	8	5	6
10	13	7	9
12	18	10	13
14	25	14	18
16	32	18	23

Areas in table have been derived using a water pressure of 225 pounds per square inch and a soil resistance of 2000 pounds per square foot.

9605. Thrust blocks are satisfactory where soil is suitable. Table 9605 gives bearing areas against undisturbed vertical wall of a trench in soil equivalent to sand and gravel cemented with clay. For other soils, the values in the table should be multiplied by an appropriate factor.

Suggested factors are:

Soft Clay	4
Sand	2
Sand and Gravel	1.33
Shale	0.4

9606. Thrust blocks shall be cast in place at each change in the direction of a pipe line and at all tees, plugs, caps and bends. The thrust blocks shall be of concrete of a mix not leaner than 1 part cement, $2\frac{1}{2}$ parts sand, and 5 parts stone. Backing shall be placed between solid ground and the fitting to be anchored and shall be of such bearing area as to assure adequate resistance to the thrust to be encountered. In general, backing shall be so placed that the joints will be accessible for inspection and repair. Thrust blocks are not suitable for vertical pipe.

9607. Down steep hills, mains shall be properly anchored to prevent slipping. A general rule is to anchor the pipe at the bottom of the hill, at any turns, and otherwise on straight runs about every forty-eight feet. The anchoring shall be done either to natural rock or by means of brick or concrete piers built on the downhill side of the bell. Bell ends shall be installed facing uphill.

97. Back Filling.

9701. Earth shall be well tamped under and around pipes (and puddled where possible) to prevent settlement or lateral movement, and shall contain no ashes, cinders or other corrosive materials.

9702. Rocks shall not be rolled into trenches and allowed to drop on pipes.

9703. In trenches cut through rock, back filling shall preferably be entirely of earth. In any case earth shall be used under and around pipe, and for at least 2 feet above.

FIGURES 96. GENERAL INFORMATION

Except for the case of welded joints with steel pipe and special joints for cast iron pipe such as provided by approved mechanical joint retaining glands, the usual joints for underground pipe and fittings are expected to be held in place by the soil in which the pipe is buried. Bell and spigot joints, caulked or with gaskets, and the standard mechanical joint (which is a gasketed joint) have limited ability to resist separation due to movement of the pipe. The sketches in this series of figures show acceptable methods of providing anchorage. There is no particular significance to be attached to whether the sketch shows a bell and spigot joint or a standard mechanical joint. The anchoring procedure illustrated applies in most cases to either type of joint. In some cases, dimensions of the particular pipe or fitting hubs and space available for working around the particular joint will influence the choice of methods used.

Rods, clamps, straps and washers shall be steel of modified range merchant quality as defined in Standard for Open Hearth Hot Rolled Steel Rods or Bars, U. S. Federal Standard No. 66B, change notice No. 4, April 30, 1964 as promulgated by the U. S. Federal Government, General Services Administration. Cast iron washers shall be of Class A cast iron as defined by Standard Specifications for Gray Iron Castings for Valves, Flanges and Pipe Fittings, ASTM A126-66. Bolting shall be steel as defined in Standard Specifications for Low-Carbon Steel Externally and Internally Threaded Standard Fasteners, ASTM A307-67. Rod couplings or turnbuckles shall be malleable iron the minimum requirements of which conform to Standard Specifications for Cupola Malleable Iron, ASTM 197-47 (Re-approved 1965) (ASTM refers to American Society for Testing and Materials, 1916 Race St., Philadelphia, Pa. 19103).

NOTE 1. In certain of the assemblies of rods and clamps shown, rods run from a lug on the fitting (or a clamp behind the hub of a bell) to a clamp against a face of a bell. Note that this arrangement anchors only one joint. The stability of the joint where the clamp is against the face of the bell depends on having soil above a relatively long piece of pipe on both sides of the joint. Consequently, if the distance between the first and second joints is less than 12 feet, the second joint shown shall be anchored by a clamp behind the hub of the bell and rods to a clamp at the face of the next bell.

NOTE 2. In the assemblies shown for rods to flanged fittings, note that the flanged fitting is not to be buried in soil.

NOTE 3. The assemblies shown in which an anchor is made by means of two clamps canted on the long spigot end of a fitting may be used if approved for the specific installation by the authority having jurisdiction.

NOTE 4. Whenever U-rods or yokes are used, sufficient torque shall be applied to the nuts to allow the rods to orient themselves as they would under full test pressure, and thus eliminate deflection during the test.

NOTE 5. In the event of fire test pressures in excess of 250 pounds per square inch, stock sizes of the rods and strapping material should be reviewed and approved by the authority having jurisdiction.

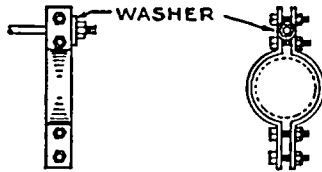

FIG. 96-1. PIPE CLAMP

Clamps shall be $\frac{1}{2}$ by 2 inches for pipe 4 and 6 inches diameter; $\frac{5}{8}$ by $2\frac{1}{2}$ inches for pipe 8 and 10 inches; $\frac{3}{4}$ by 3 inches for pipe 12 inches. Bolt holes shall be $\frac{1}{16}$ -inch diameter larger than bolts.

Rods shall be $\frac{3}{4}$ inches diameter for pipes 4, 6 and 8 inches diameter; $\frac{7}{8}$ inches for pipe 10 inches and 1 inch diameter for pipe 12 inches.

Bolts shall be $\frac{5}{8}$ inches diameter for pipe 4, 6 and 8 inches diameter; $\frac{3}{4}$ inches for pipe 10 inches and $\frac{7}{8}$ inches diameter for pipe 12 inches.

Washers may be cast iron or steel, round or square. Dimensions for cast iron washers are $\frac{5}{8}$ by 3 inches for pipe 4, 6, 8 and 10 inches diameter and $\frac{3}{4}$ by $3\frac{1}{2}$ inches for pipe 12 inches. Dimensions for steel washers are $\frac{1}{2}$ by 3 inches for pipe 4, 6, 8 and 10 inches diameter and $\frac{1}{2}$ by $3\frac{1}{2}$ inches for pipe 12 inches. Holes shall be $\frac{1}{8}$ inches larger than the rods.

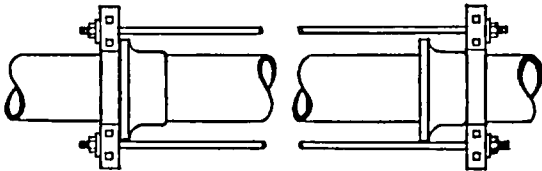

FIG. 96-2. PIPE ANCHOR

If distance between joints is less than 12 feet, see Note 1.

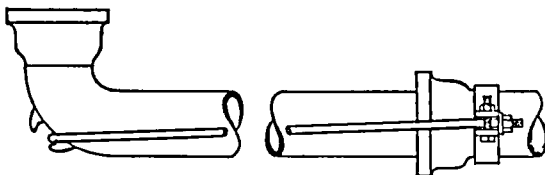
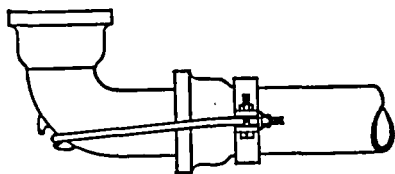
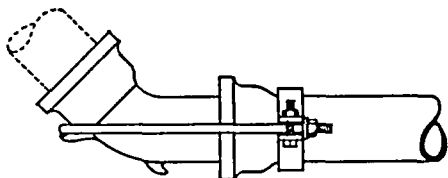
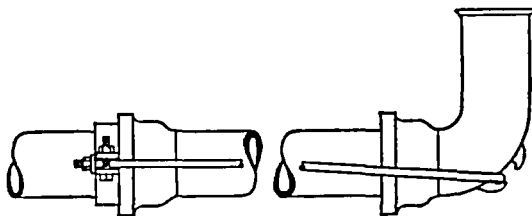
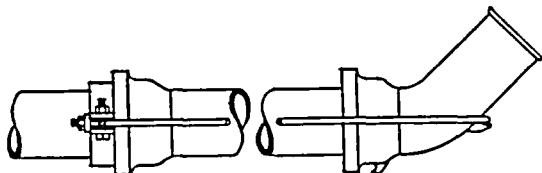

FIG. 96-3. ANCHOR FOR LONG SPIGOT $\frac{1}{4}$ BEND

Short hairpin bend and rod couplings may be used in this assembly

FIG. 96-4. ANCHOR FOR $\frac{1}{4}$ BEND SPIGOT ENDFIG. 96-5. ANCHOR FOR $\frac{1}{8}$ BEND SPIGOT ENDFIG. 96-6. ANCHOR FOR $\frac{1}{4}$ BEND BELL END
If distance between joints shown is less than 12 feet, see Note 1.FIG. 96-7. ANCHOR FOR $\frac{1}{8}$ BEND BELL END
If distance between joints shown is less than 12 feet, see Note 1.

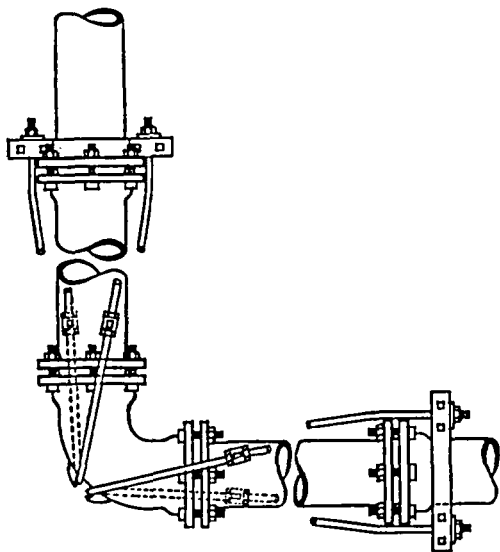

FIG. 96-8. ANCHORS AT $\frac{1}{4}$ BEND

If distance between the joint at bend and the next joint in the pipe shown vertically in the drawing is less than 12 feet, see Note 1.

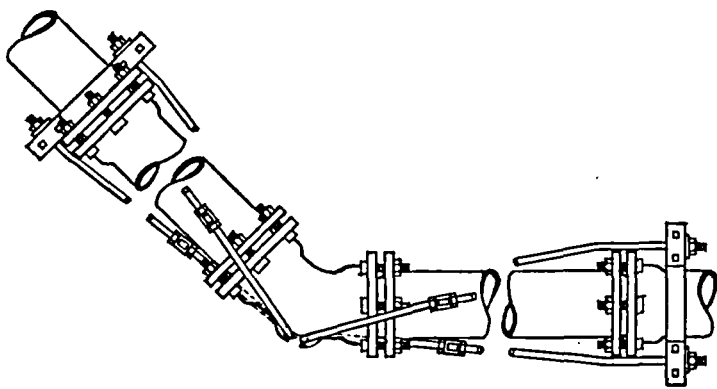

FIG. 96-9. ANCHORS AT $\frac{1}{2}$ BEND

If distance between the joint at bend and the next joint in the pipe shown in the drawing at 45 degrees from horizontal is less than 12 feet, see Note 1.

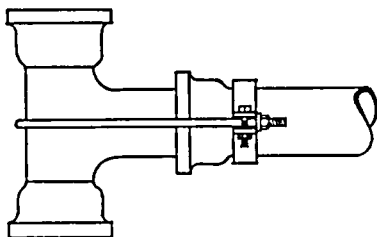

FIG. 96-10. TEE ANCHOR

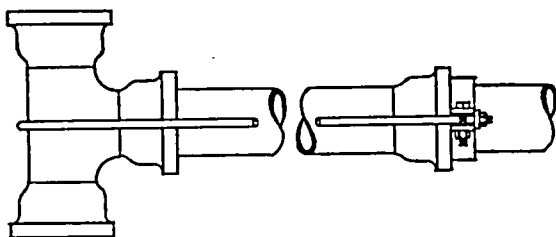

FIG. 96-11. TEE ANCHOR BELL END

If distance between joints shown is less than 12 feet, see Note 1.

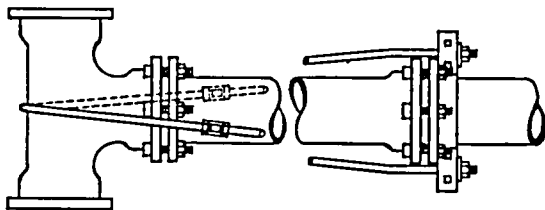

FIG. 96-12. TEE ANCHOR

Shows use of short hairpin bend and rod couplings. If distance between joints is less than 12 feet, see Note 1.

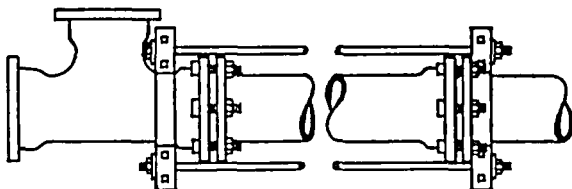

FIG. 96-13. TEE ANCHOR

If distance between joints is less than 12 feet, see Note 1.

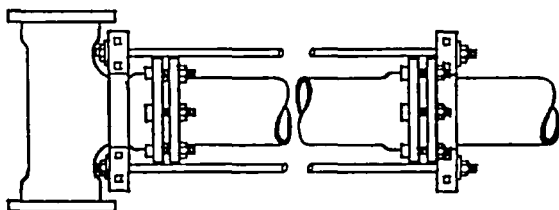

FIG. 96-14. TEE ANCHOR

If distance between joints is less than 12 feet, see Note 1.

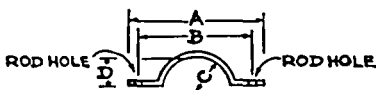

FIG. 96-15. ANCHOR STRAP FOR TEES

(See also Figs. 96-16, 96-17 and 96-18)

Straps shall be $\frac{5}{8}$ inches thick and $2\frac{1}{2}$ inches wide for pipe diameters 4, 6, 8 and 10 inches; 3 inches wide for pipe 12 inches. Rod holes shall be $\frac{1}{16}$ inch larger than rods. Dimensions in inches for straps are suitable either for mechanical joint or bell and spigot fittings.

Pipe Size	A	B	C	D
4	12½	10½	2½	1¾
6	14½	12½	3-9/16	2-13/16
8	16¾	14¾	4-21/32	3-29/32
10	19-1/16	16-11/16	5¾	5
12	22-5/16	19-3/16	6¾	5½

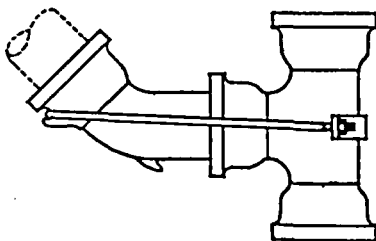

FIG. 96-16. ANCHOR FOR BELL END TEE AND $\frac{1}{4}$ BEND SPIGOT END

See Fig. 96-15 for strap detail.

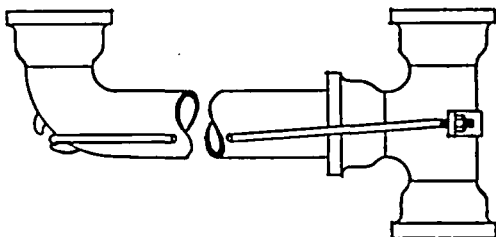

FIG. 96-17. ANCHOR FOR BELL END TEE AND $\frac{1}{4}$ BEND SPIGOT END

See Fig. 96-15 for strap detail.

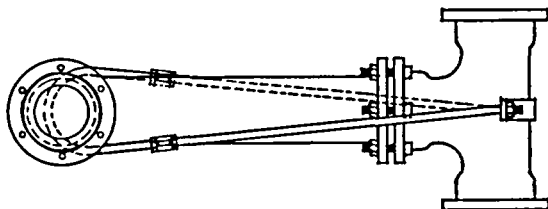

FIG. 96-18. ANCHOR FOR BELL END TEE AND $\frac{1}{4}$ BEND SPIGOT END

Shows use of short hairpin bend and rod couplings. See Fig. 96-15 for strap detail.